

REV	DESCRIPTION	DESIGN	DATE
A0	NEW RELEASE	吴丹平	2015/10/23
A1	按当前机台可管控精度更改公差	Jiangjanyin	2019/08/17

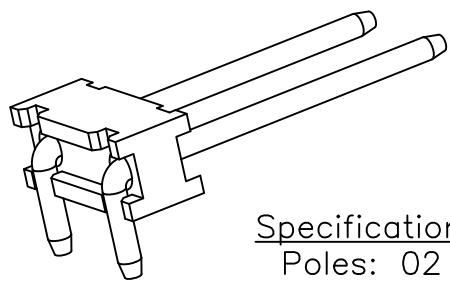

Specifications:

- Poles: 02
- Contact resistance: $\leq 20m\Omega$
- Insulation resistance: $\geq 1000M\Omega$
- Rated voltage: 250V AC DC
- Rated current: 2.0A AC DC
- Withstand Voltage: 2000V AC/minute
- Temperature Range: $-40^{\circ}C \sim +110^{\circ}C$
- Housing: PA46 UL94V-0, Natural (Beige)
- Contacts: Brass/Ni-plated

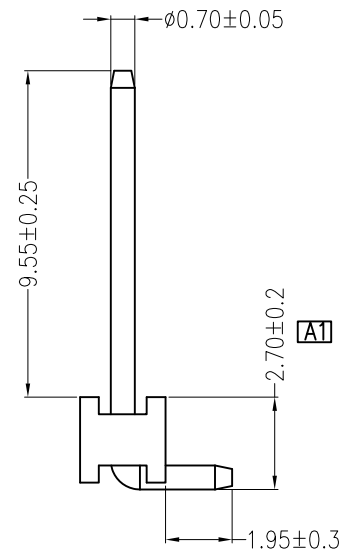
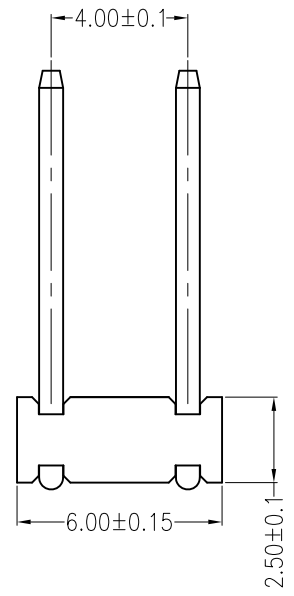
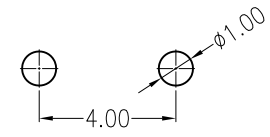
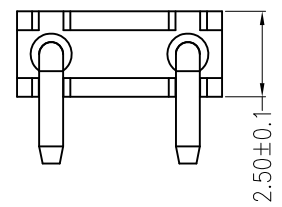

SUGGESTED PCB LAYOUT
(COMPONENT SIDE)

ORDER INFORMATION:

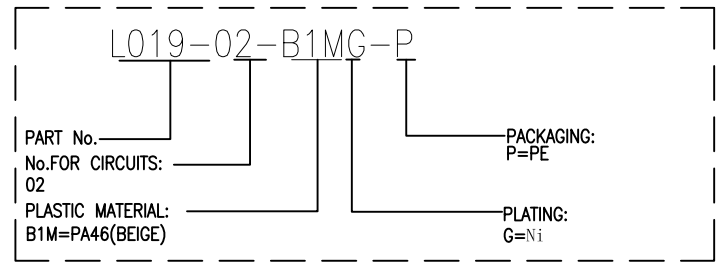

東莞市高迪電子有限公司 DONG GUAN GAO DI ELECTRONICS CO., LTD		TITLE: -	
		PART NO.: L019-02-B1MG-P	
GENERAL TOLERANCE		USE: CUSTOMER	
X. ±0.50	X. ±5°	APPD: Liuzhenling	
X.X ±0.30	X.X ±2°	CHKD: Wangliang	
X.XX ±0.20	X.XX ±1°	DR: Jiangjanyin	
UNITS: mm		SCALE 1 : 1	SHEET 1 / 1

REV	DESCRIPTION	DESIGN	DATE
A0	NEW RELEASE	李润	2016/03/28
A1	按当前机台可管控精度更改公差	Jiangjanyin	2019/08/17

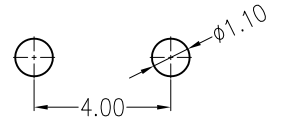
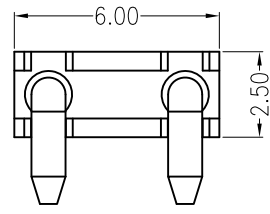
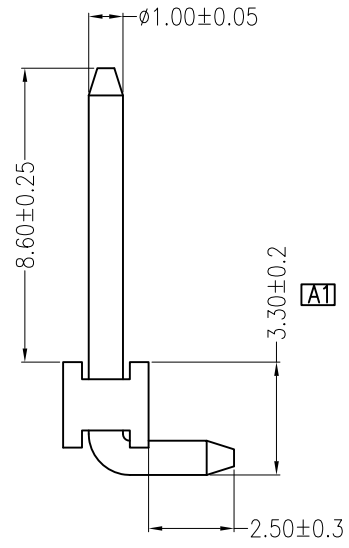
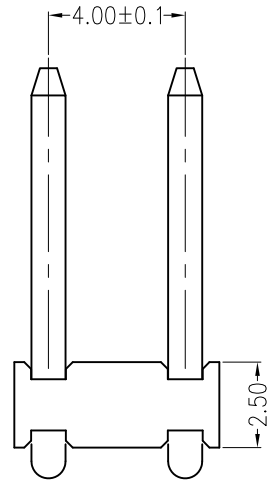
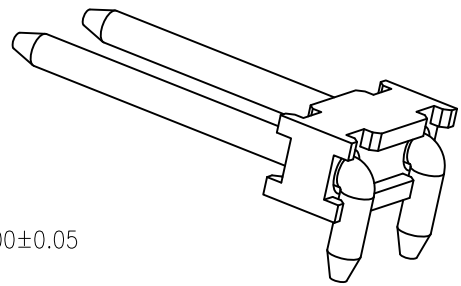

SUGGESTED PCB LAYOUT
(COMPONENT SIDE)

Specifications:

- Poles: 02
- Contact resistance: ≤20mΩ
- Insulation resistance: ≥1000MΩ
- Rated voltage: 250V AC DC
- Rated current: 2.0A AC DC
- Withstand Voltage: 2000V AC/minute
- Temperature Range: -40°C ~ +110°C
- Housing: PA46 UL94V-0, Natural (Beige)
- Contacts: Brass/Ni-plated

ORDER INFORMATION:

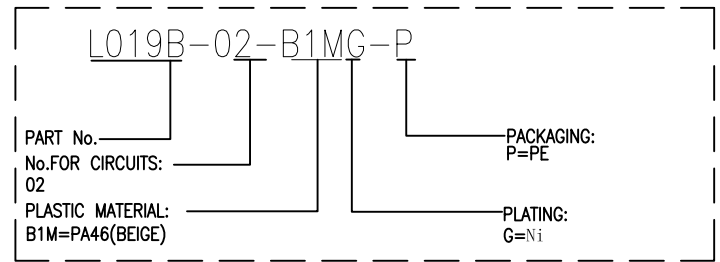

東莞市高迪電子有限公司 DONG GUAN GAO DI ELECTRONICS CO., LTD		TITLE: -	
		PART NO.: L019B-02-B1MG-P	
GENERAL TOLERANCE		USE: CUSTOMER	
X. ±0.50	X. ±5°	APPD: Liuzhenling	
X.X ±0.30	X.X ±2°	CHKD: Wangliang	
X.XX ±0.20	X.XX ±1°	DR: Jiangjanyin	
UNITS: mm		SCALE 1 : 1	SHEET 1 / 1